

DETAIL B
SCALE 1:4

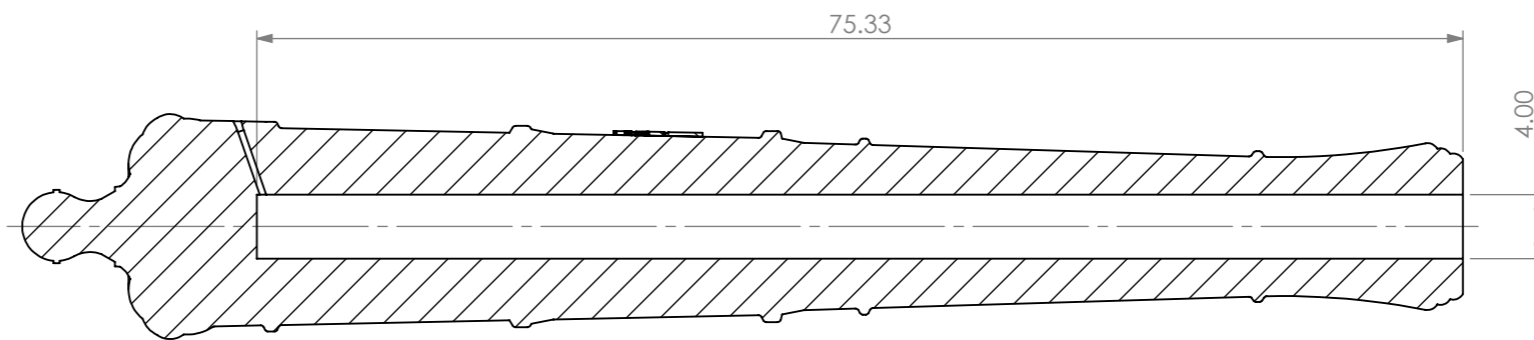
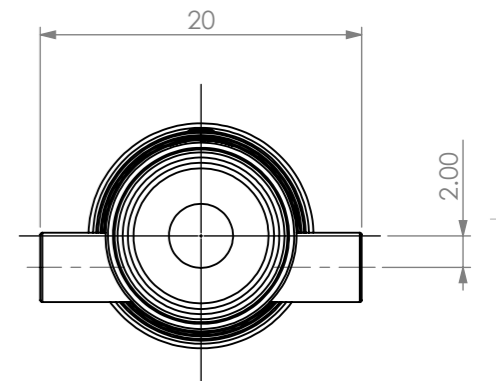
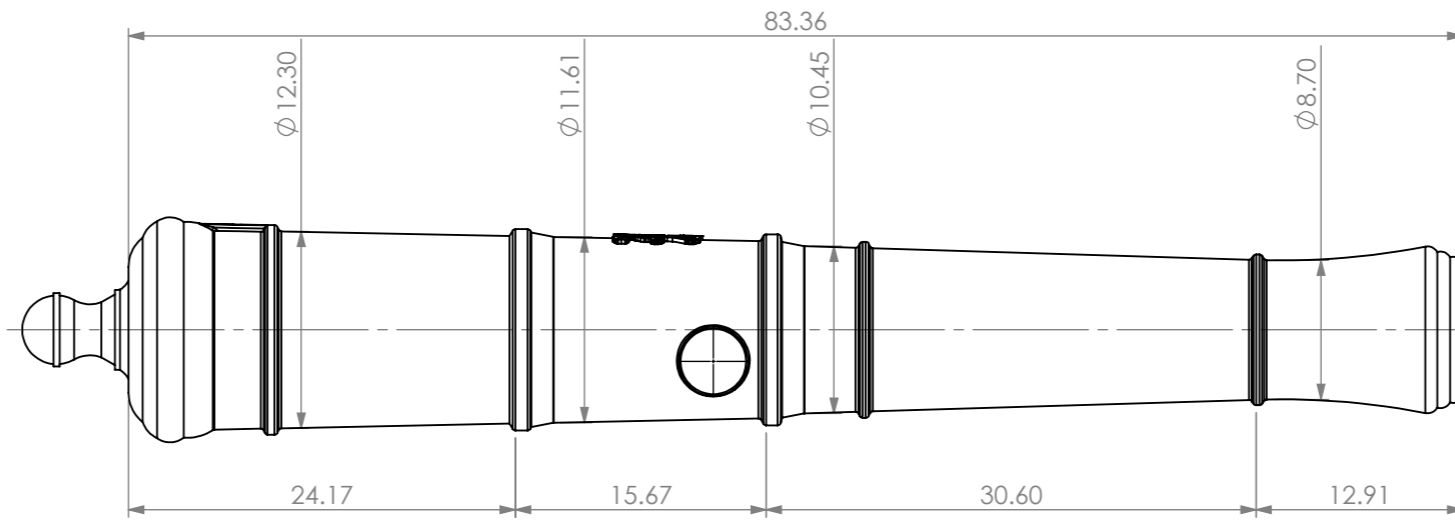
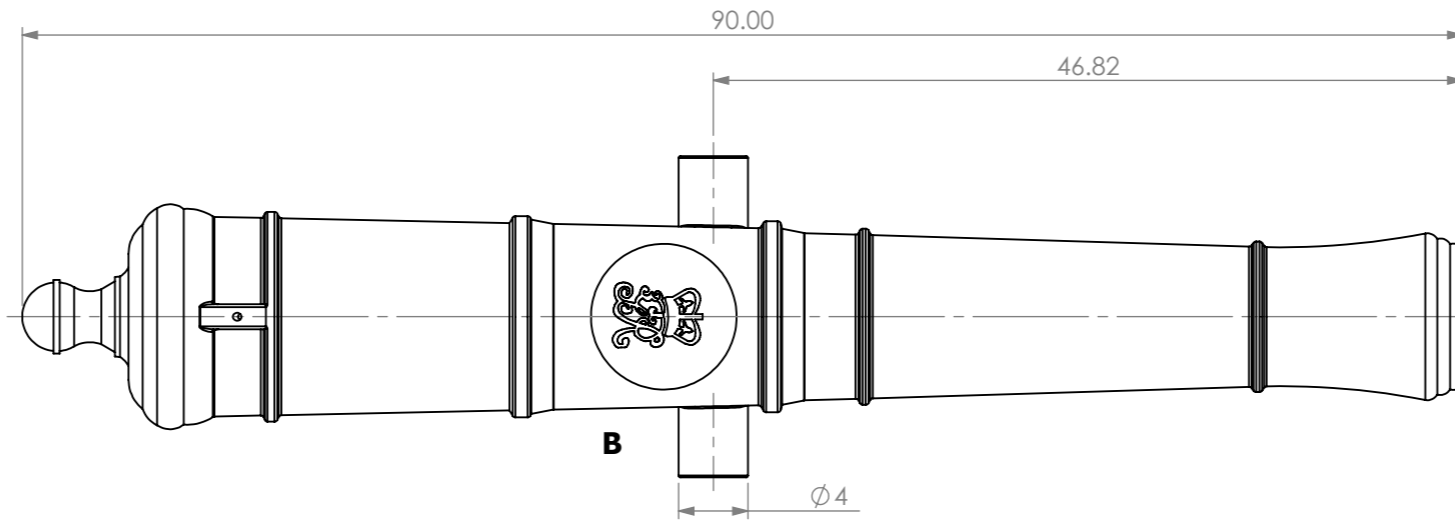
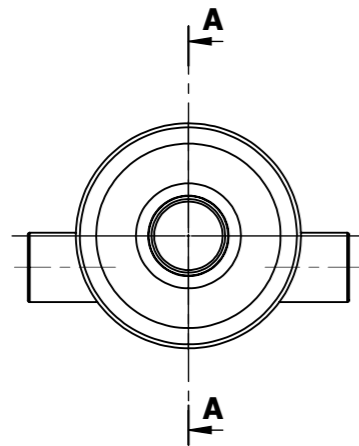

SECTION A-A

SHEET 2 OF 2

**ARMSTRONG PATTERN
9 POUND CANNON**

© COPYRIGHT MSW

SCALE:1:12

A3